

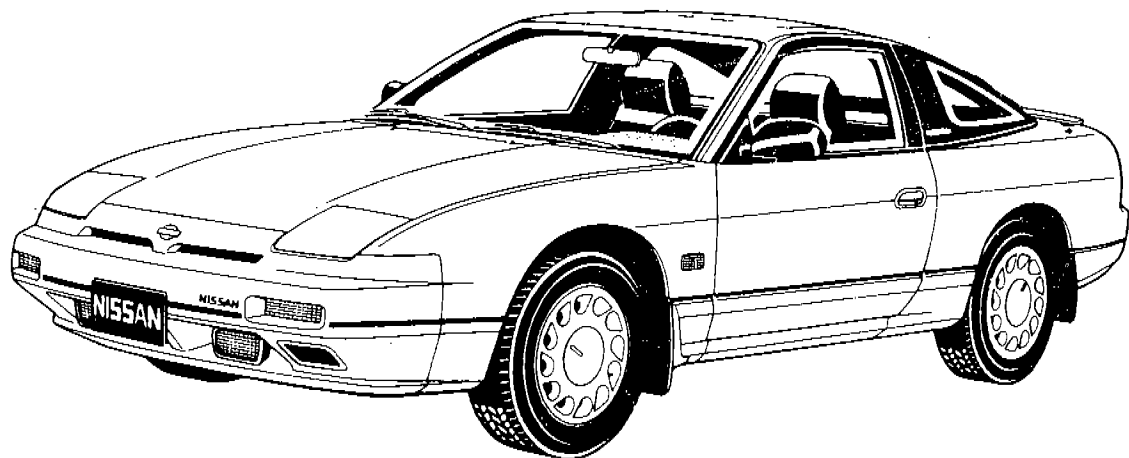

NISSAN 200SX

MODEL S13 SERIES



SERVICE MANUAL

NISSAN 200SX (S13 series) CIRCUIT DIAGRAM

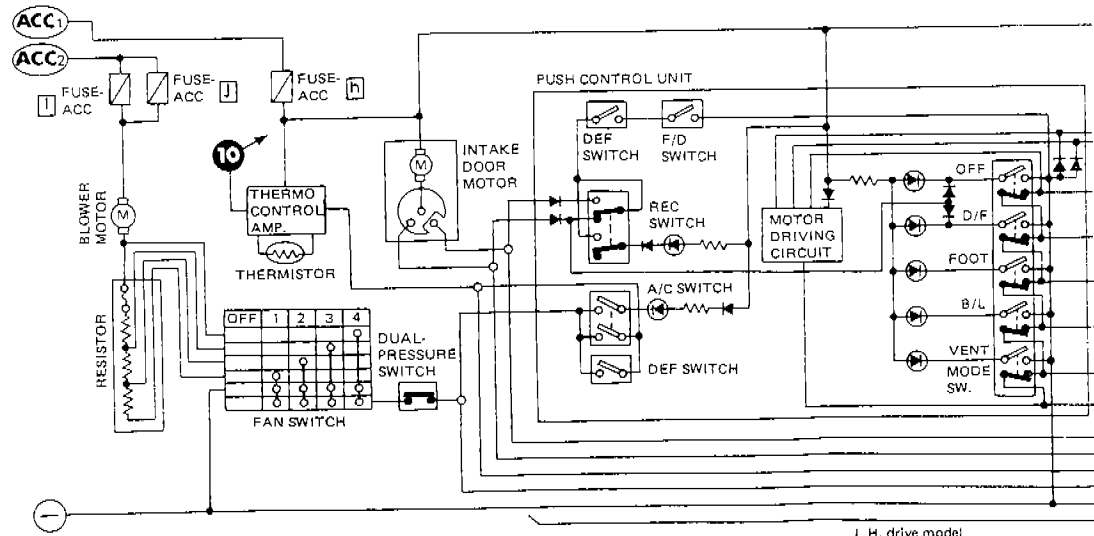
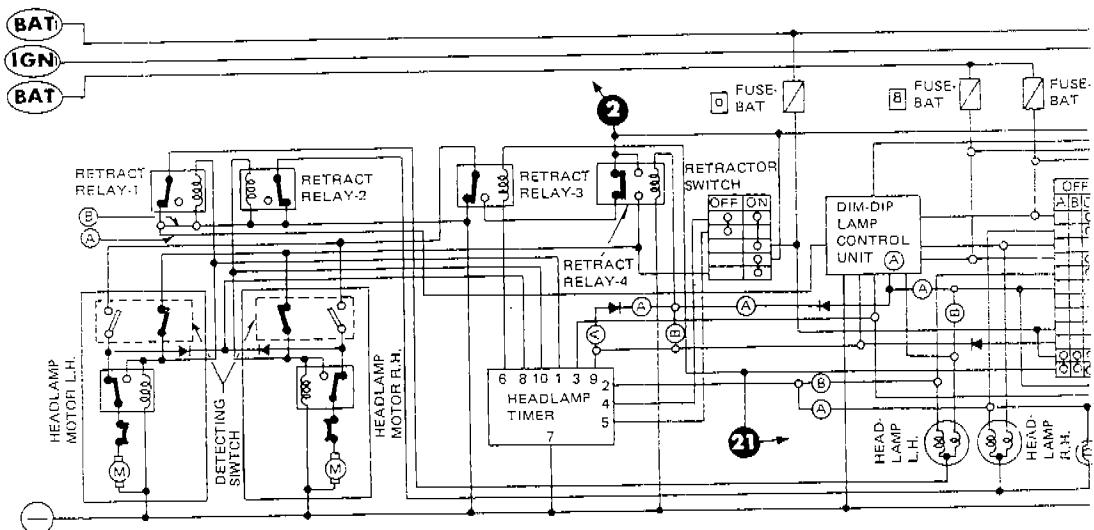
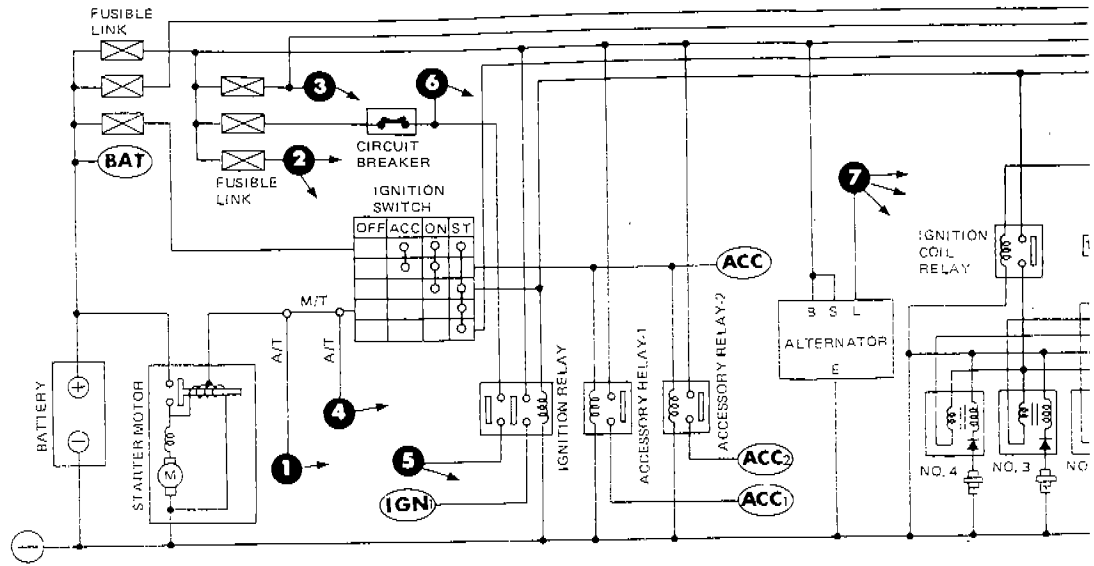

L.H. drive model

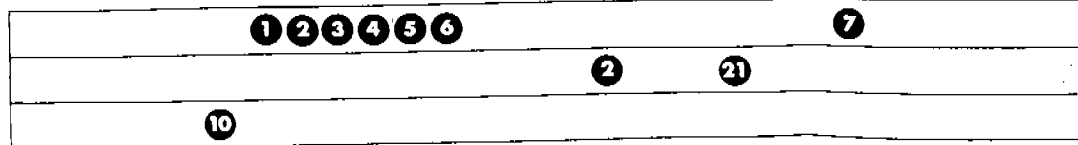

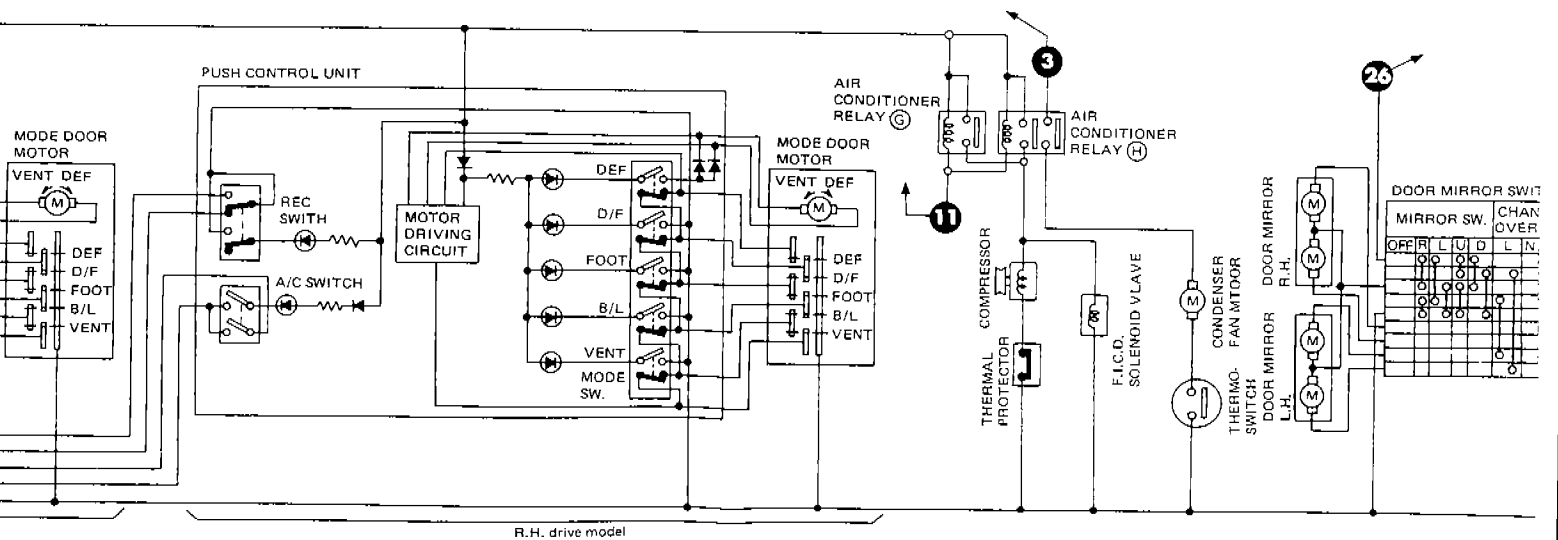
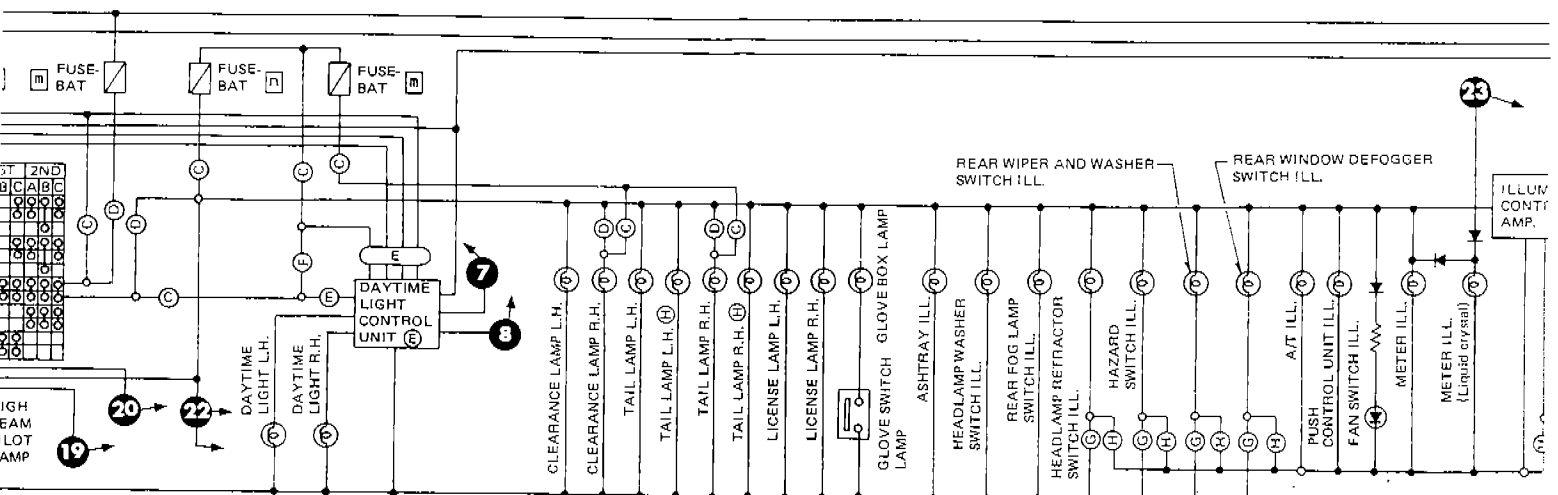
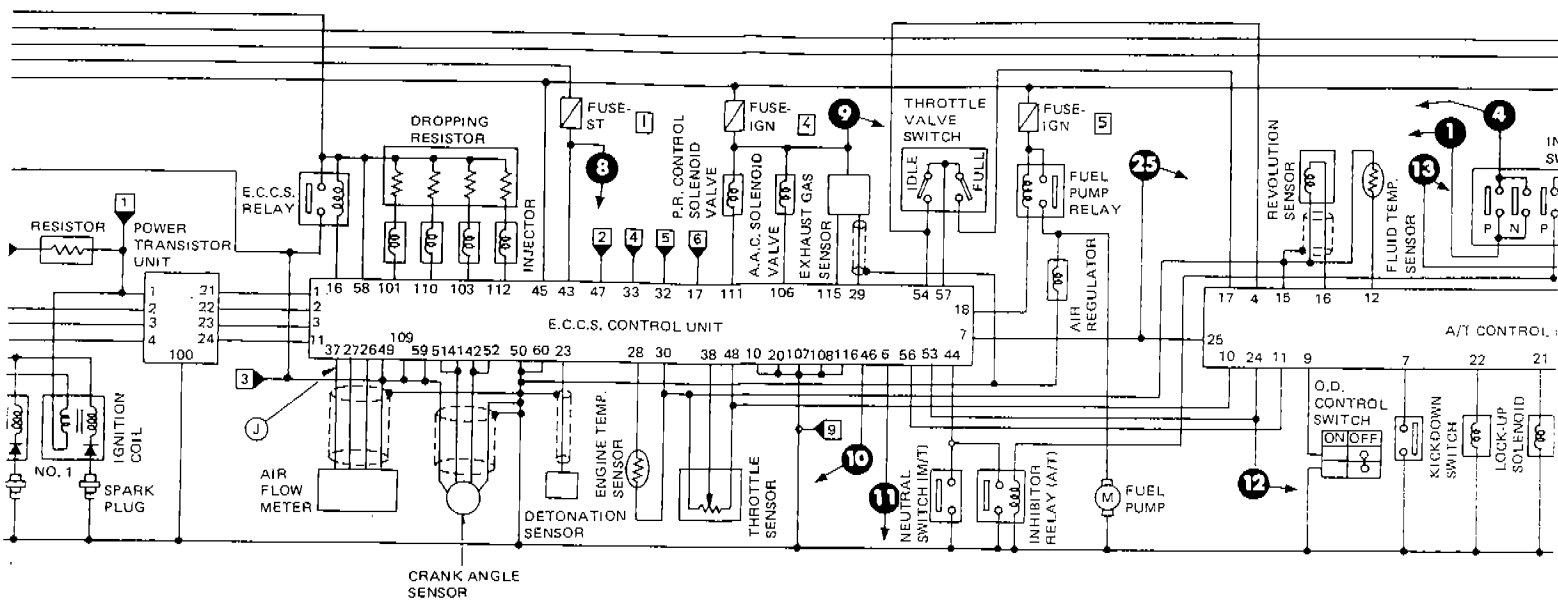

- 19 20 22 7 8 9 10 11 25 12 13 1 4 23 11 3 26

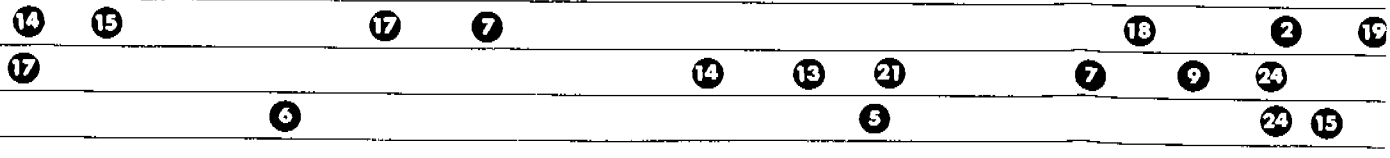
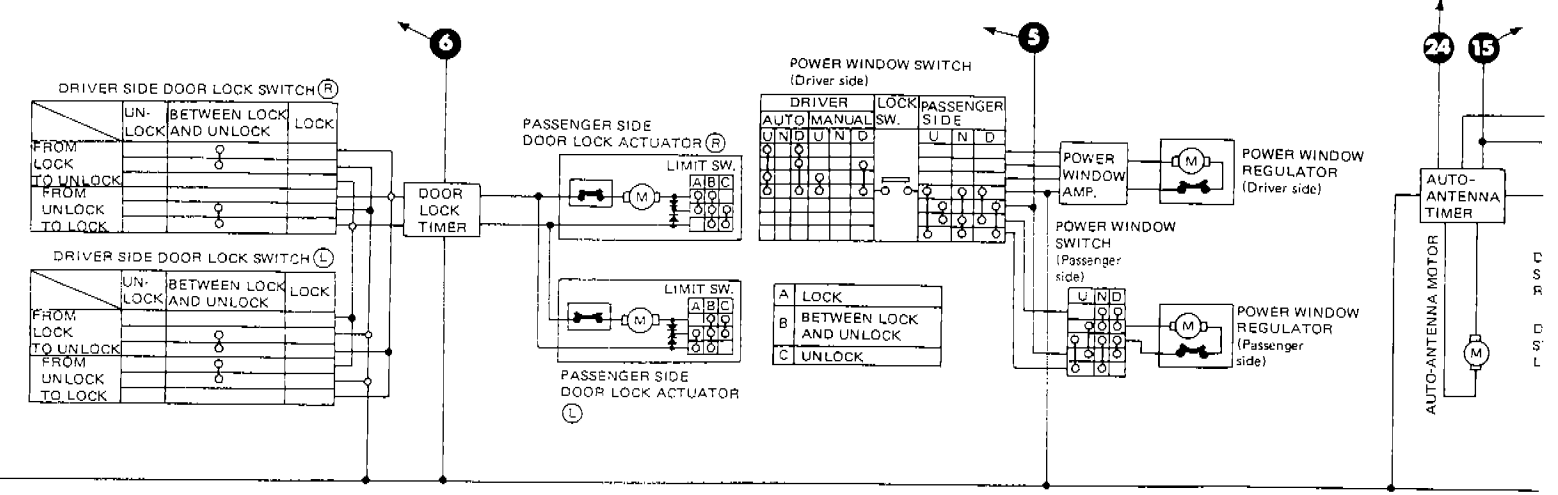
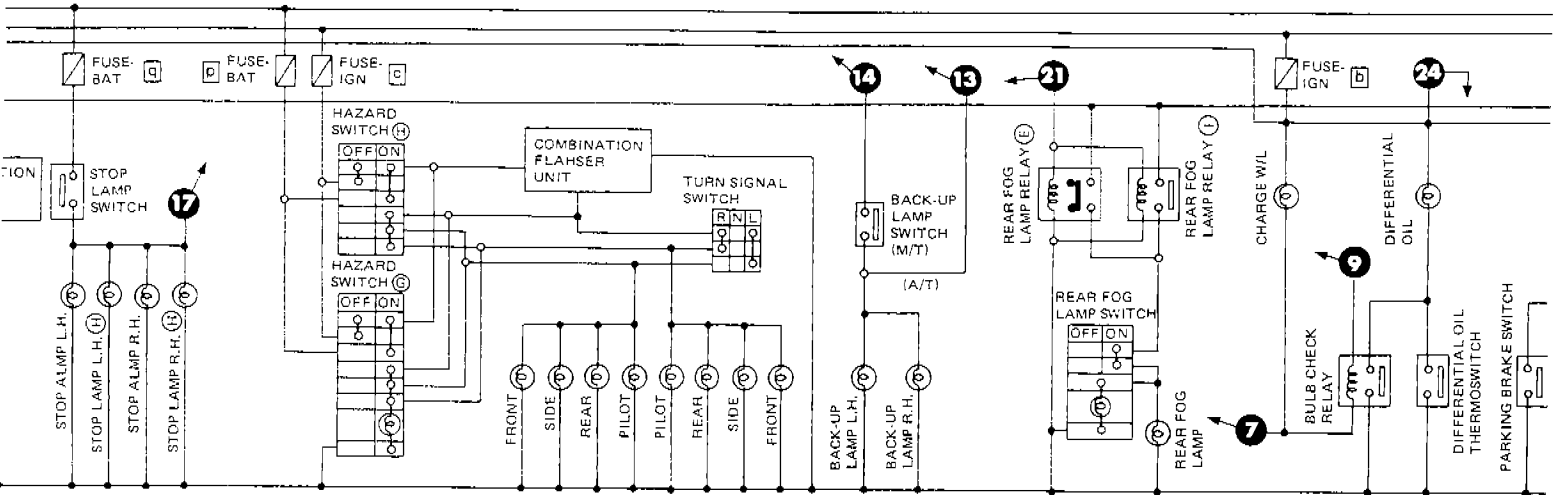
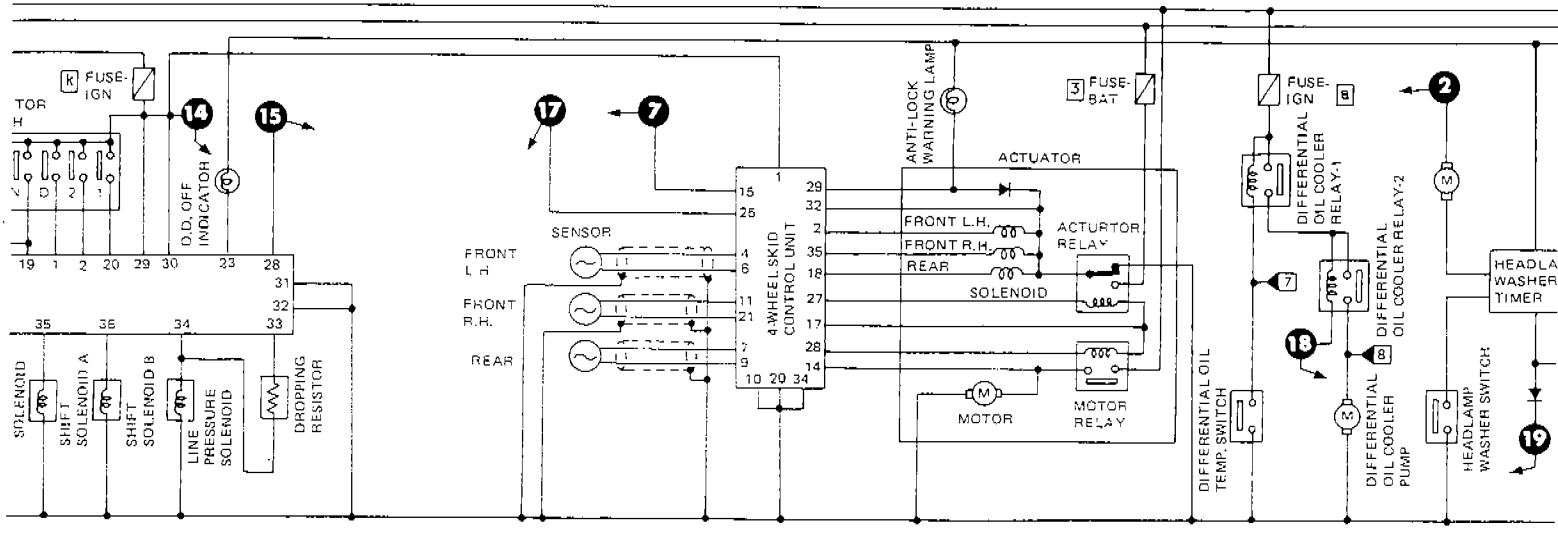

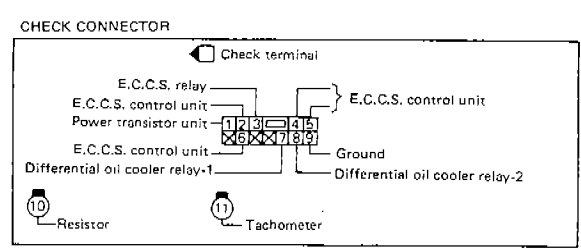
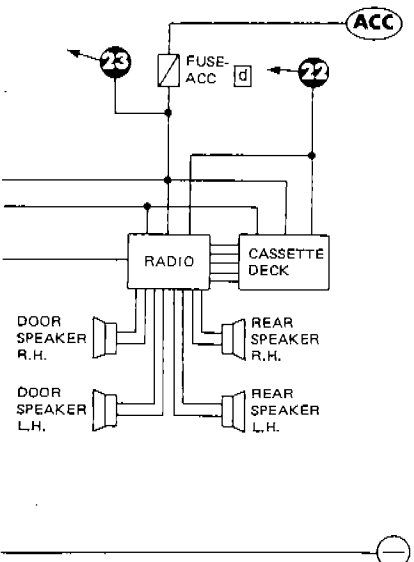
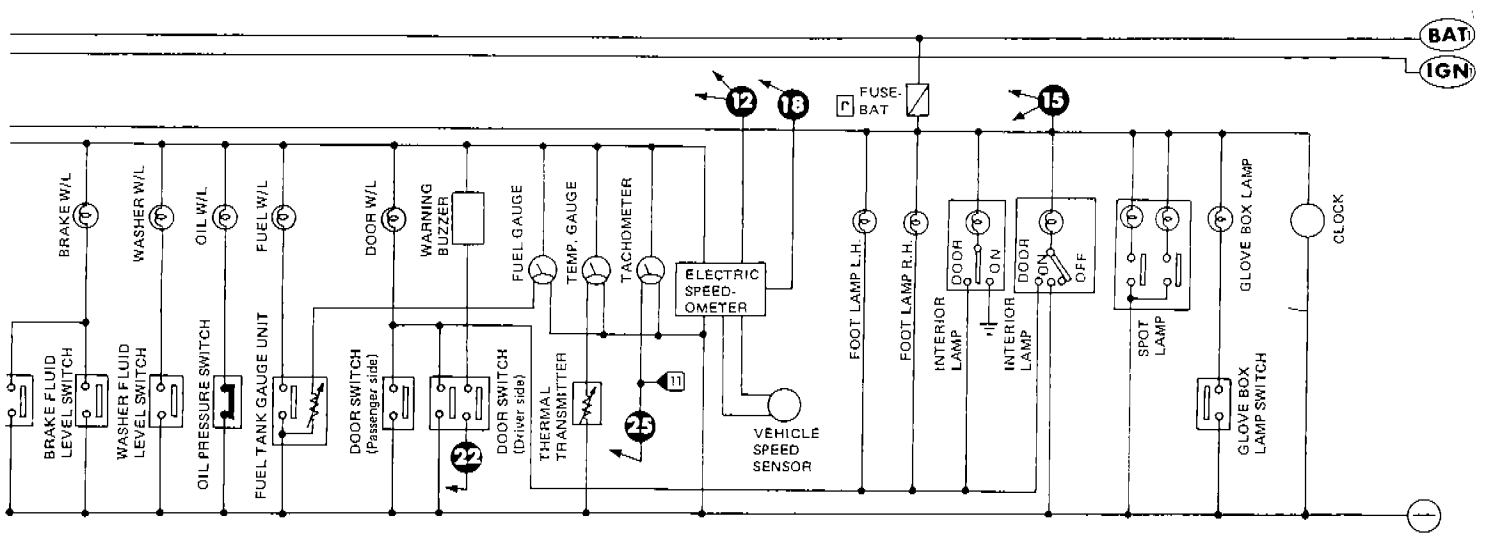
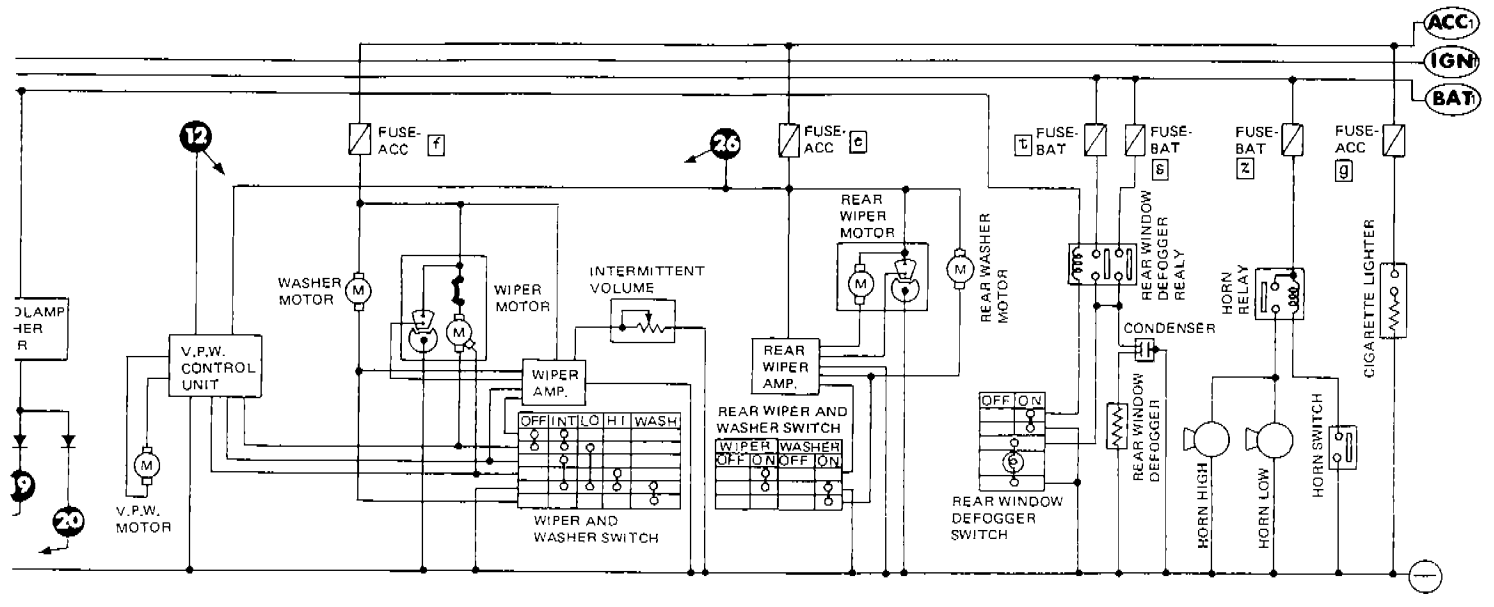

- (M/T) : M/T model
(A/T) : A/T model
- Ⓐ : Model with dim-dip lamp system
 - Ⓑ : Except Ⓐ
 - Ⓒ : L.H. drive model for Europe
 - Ⓓ : Except Ⓒ
 - Ⓔ : Model with daytime light system
 - Ⓕ : L.H. drive model for Europe without daytime light system
 - Ⓖ : L.H. drive model
 - Ⓗ : R.H. drive model
 - Ⓙ : For Europe
 - Ⓚ : Except for Europe
 - Ⓛ : Except Ⓚ
 - Ⓜ : Model without catalyzer

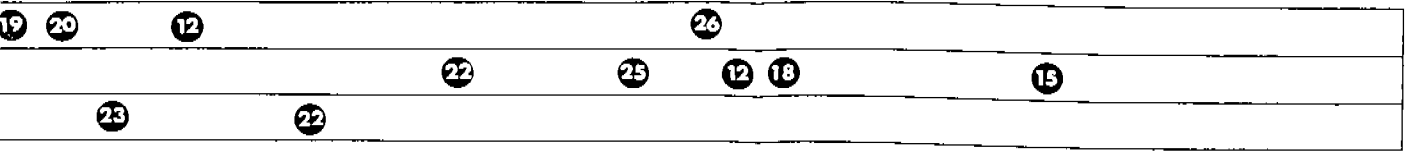
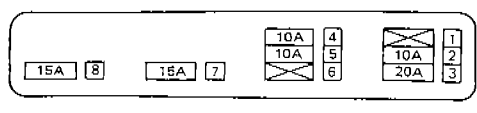
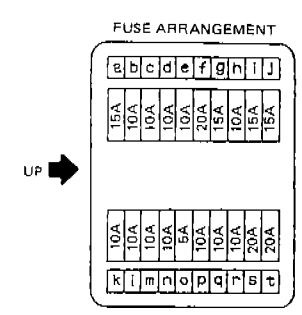

NISSAN 200SX E. C. C. S. WIRING DIAGRAM

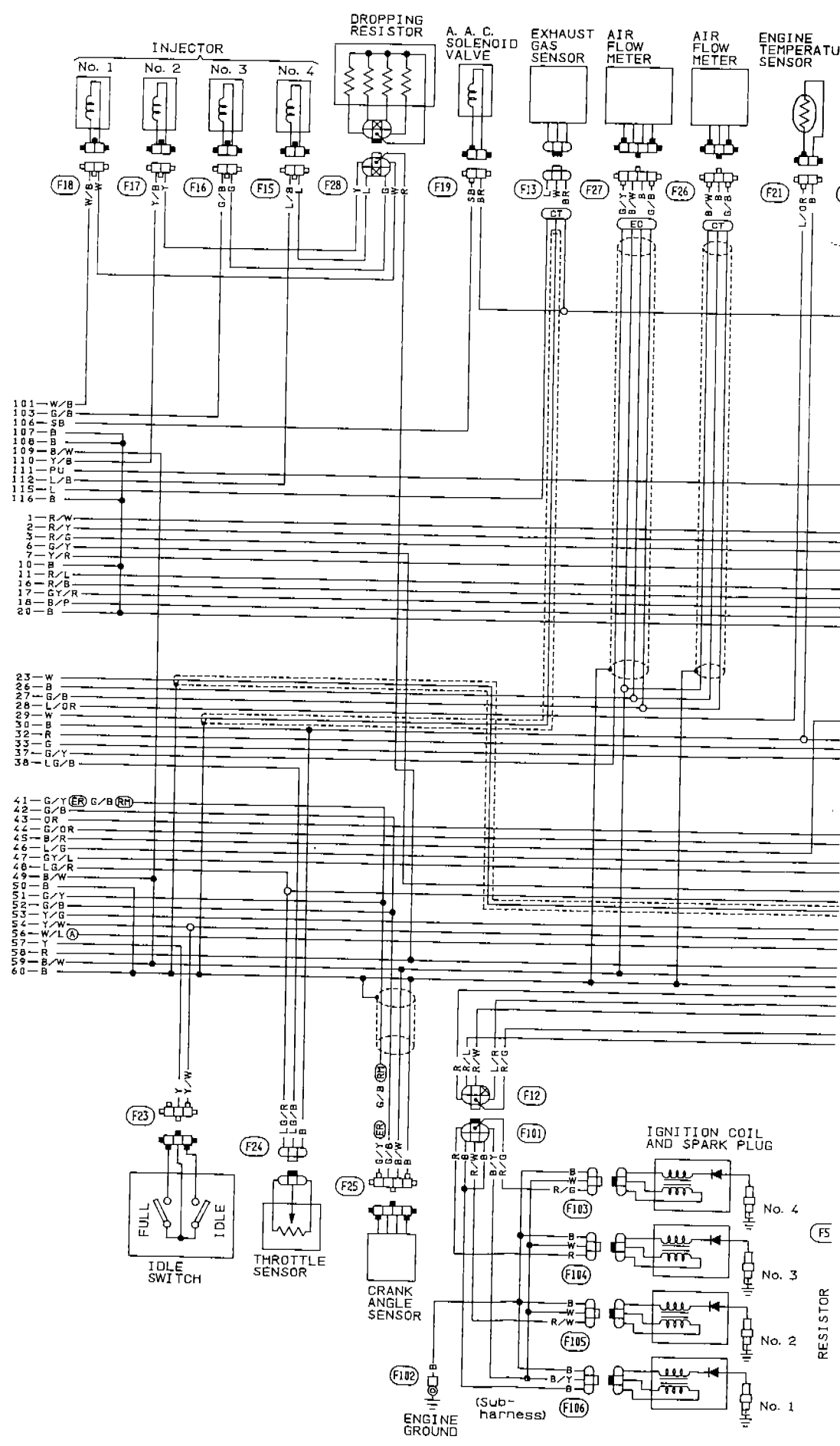
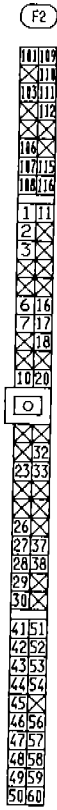
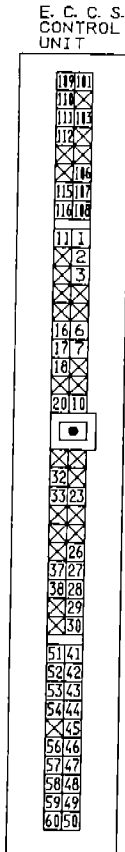

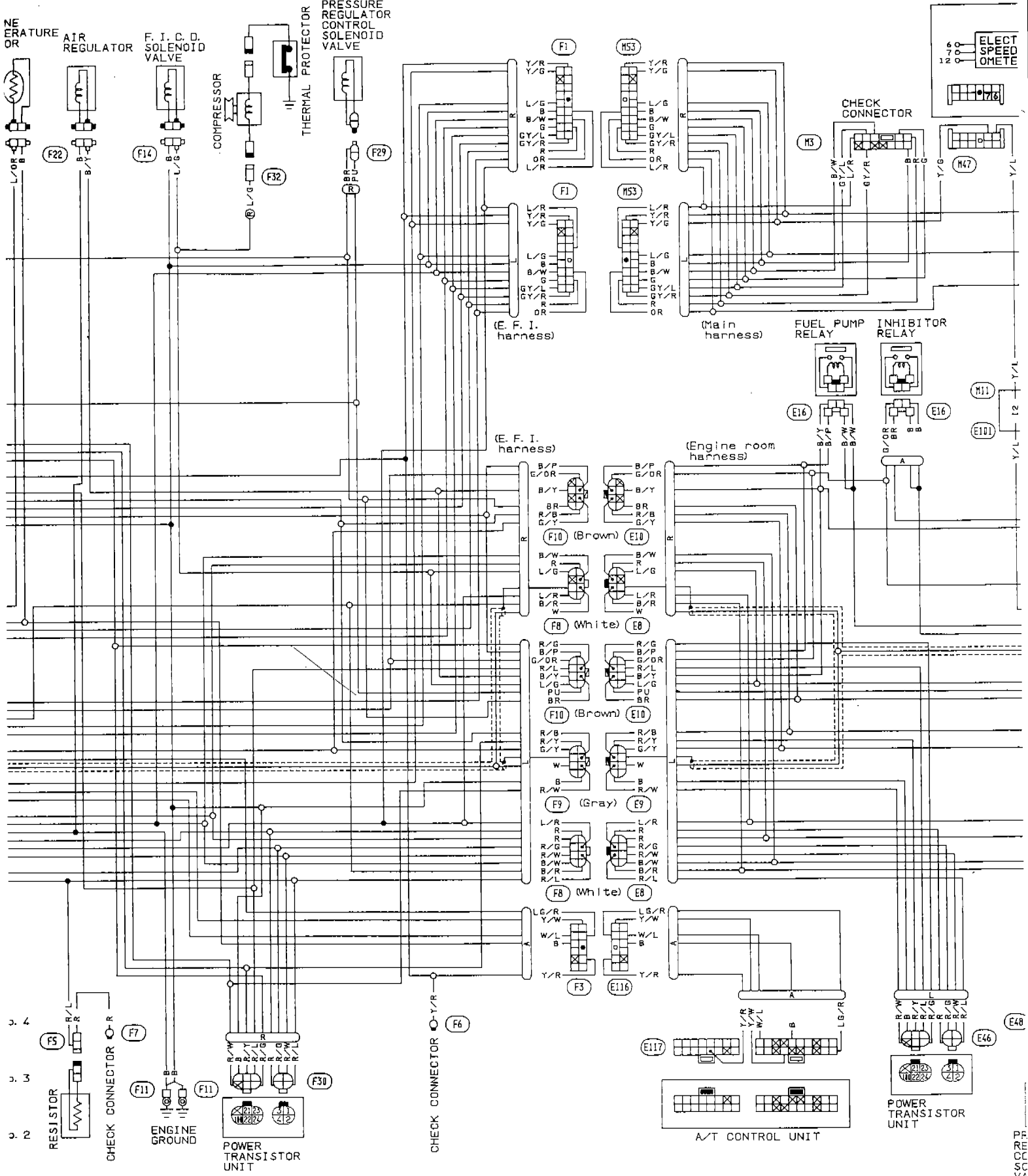

COMBINATION METER

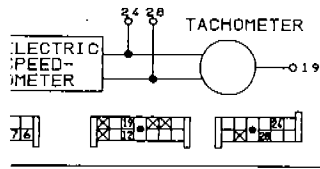

To A/C switch
(In PUSH CONTROL UNIT,
refer to HA section.)

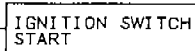
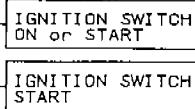
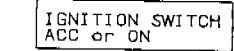
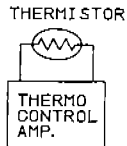

- (L) : L. H. drive model
- (R) : R. H. drive model
- (A) : A/T model
- (M) : M/T model
- (E) : For Europe
- (G) : Except for Europe
- (RM) : R. H. drive M/T model
- (ER) : Except (RM)
- (CT) : For model with catalyzer
- (EC) : Except (CT)

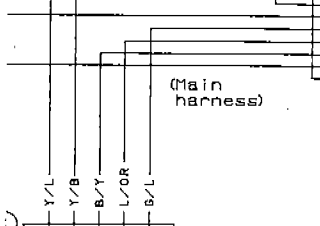
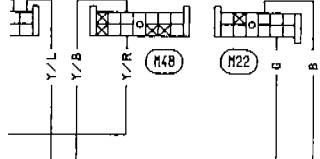
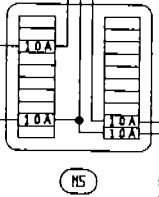
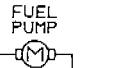

S. M. J.
(Refer to last page
(Foldout page).)

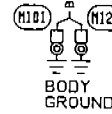
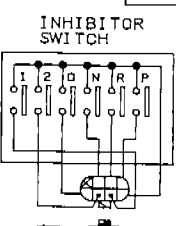

IGNITION SWITCH

	OFF	ACC	ON	ST
1				
2				
3				
4				
5				

